

HIGH VOLTAGE HIGH SPEED POWER SWITCH APPLICATION.

- Built-in Free wheeling Diode makes efficient anti saturation operation.
- Suitable for half bridge light ballast Applications.
- Low base drive requirement.

MAXIMUM RATING (Ta=25°C)

CHARACTERISTIC	SYMBOL	RATING	UNIT
Collector-Base Voltage	V_{CBO}	800	V
Collector-Emitter Voltage	V_{CEO}	400	V
Emitter-Base Voltage	V_{EBO}	10	V
Collector Current	DC	I_C	5
	Pulse	I_{CP}	10
Base Current	I_B	2	A
Collector Power Dissipation (Tc=25°C)	P_C	75	W
Junction Temperature	T_j	150	°C
Storage Temperature Range	T_{stg}	-55 ~ 150	°C

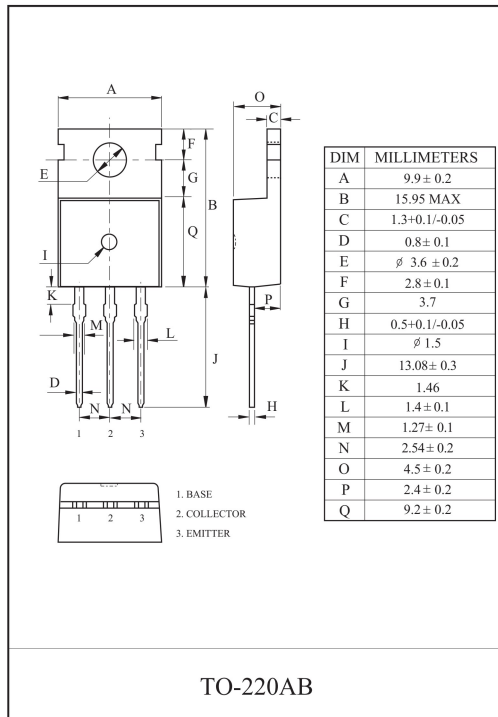

Equivalent Circuit

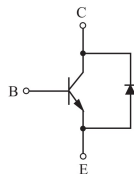

ELECTRICAL CHARACTERISTICS (Ta=25°C)

CHARACTERISTIC	SYMBOL	TEST CONDITION	MIN.	TYP.	MAX.	UNIT
Emitter Cut-off Current	I_{EBO}	$V_{EB}=9V, I_C=0$	-	-	10	μA
DC Current Gain	$h_{FE(1)}$	$V_{CE}=5V, I_C=1A$	18	-	35	
	$h_{FE(2)}$	$V_{CE}=5V, I_C=2A$	8	-	-	
Collector-Emitter Saturation Voltage	$V_{CE(sat)}$	$I_C=1A, I_B=0.2A$	-	-	0.5	V
		$I_C=2A, I_B=0.5A$	-	-	0.6	
		$I_C=4A, I_B=1A$	-	-	1	
Base-Emitter Saturation Voltage	$V_{BE(sat)}$	$I_C=1A, I_B=0.2A$	-	-	1.2	V
		$I_C=2A, I_B=0.5A$	-	-	1.6	
Collector Output Capacitance	C_{ob}	$V_{CB}=10V, f=1MHz$	-	65	-	pF
Transition Frequency	f_T	$V_{CE}=10V, I_C=0.5A$	4	-	-	MHz
Turn-On Time	t_{on}	<p>$I_{B1}=0.4A, I_{B2}=-1A$ DUTY CYCLE $\leq 2\%$</p>	-	-	0.15	μS
Storage Time	t_{stg}		2	-	5	μS
Fall Time	t_f		-	-	0.8	μS
Diode Forward Voltage	V_F	$I_F=2A$	-	-	1.6	V
*Reverse recovery tims (di/dt=10A/ μS)	t_{rr}	$I_F=0.4A$	-	800	-	nS
		$I_F=1A$	-	1.4	-	μS
		$I_F=2A$	-	1.9	-	μS

*Pulse Test : Pulse Width = 5mS, Duty cycles $\leq 10\%$

Note : h_{FE} Classification R : 18~27, O : 23~35

Fig 1. $h_{FE} - I_C$

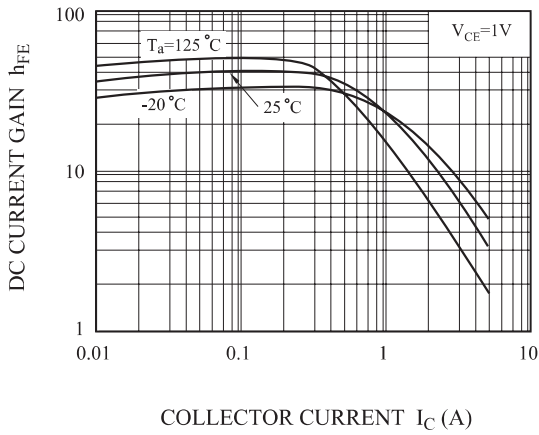

Fig 2. $V_{BE(sat)}, V_{CE(sat)} - I_C$

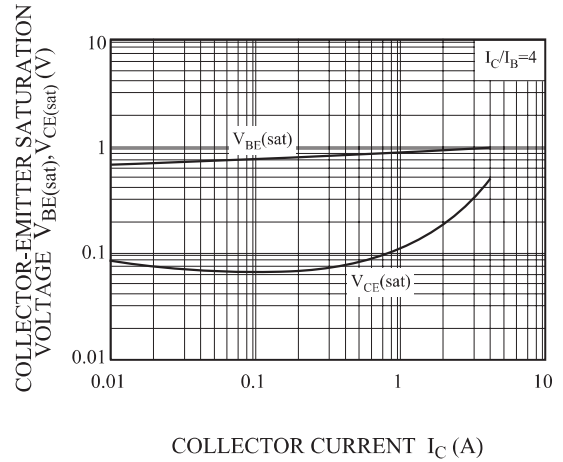

Fig 3. $h_{FE} - I_C$

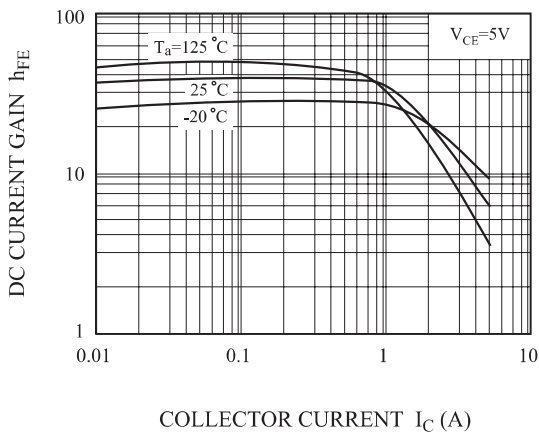

Fig 4. $C_{ob} - V_{CB}$

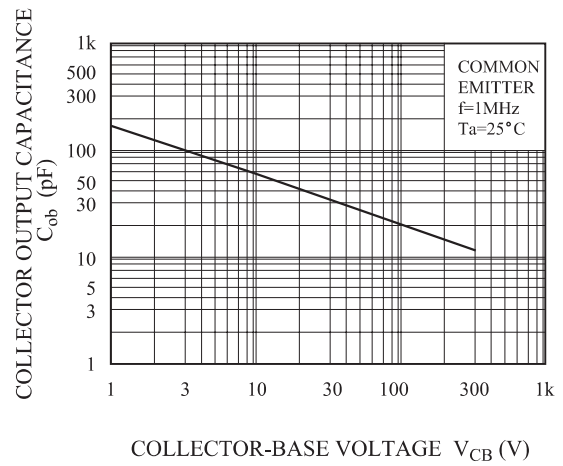

Fig 5. $I_C - V_{CE}$

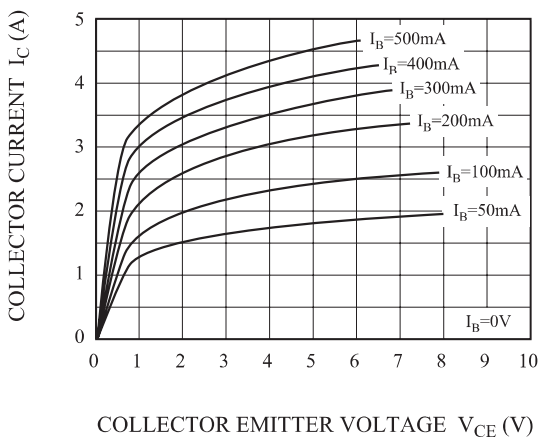

Fig 6. SWITCHING CHARACTERISTIC

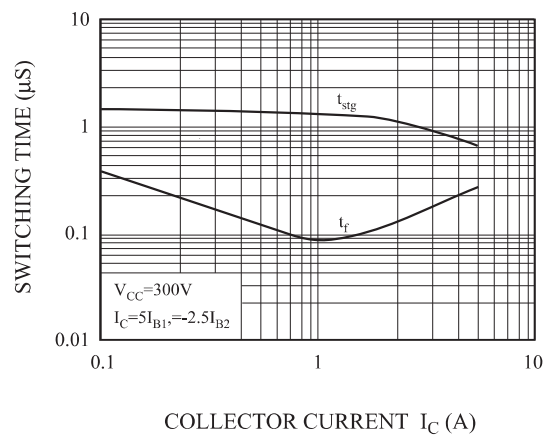

Fig 7. t_{rr} - I_F

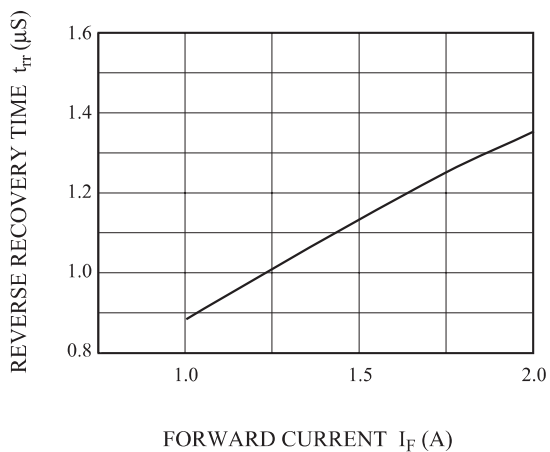

Fig 8. V_F - I_F

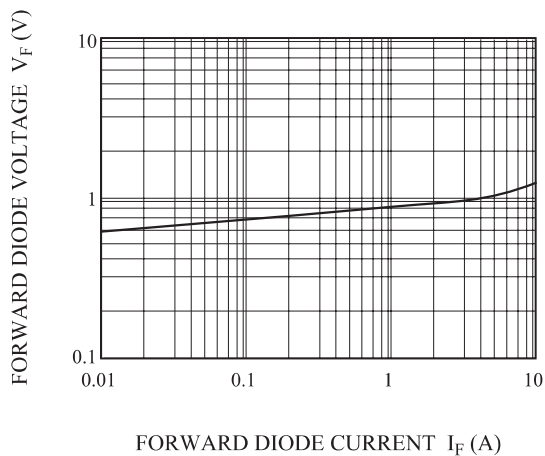

Fig 9. SAFE OPERATING AREA

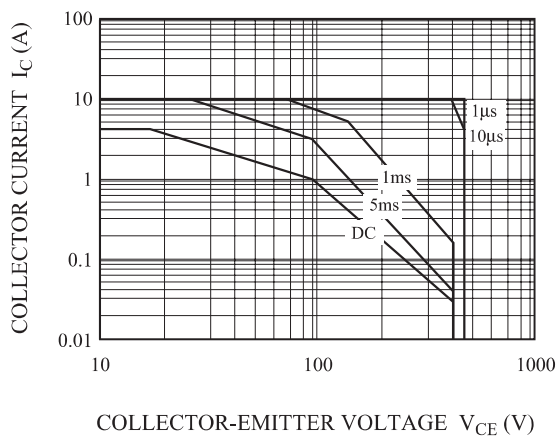

Fig 10. P_C - T_a

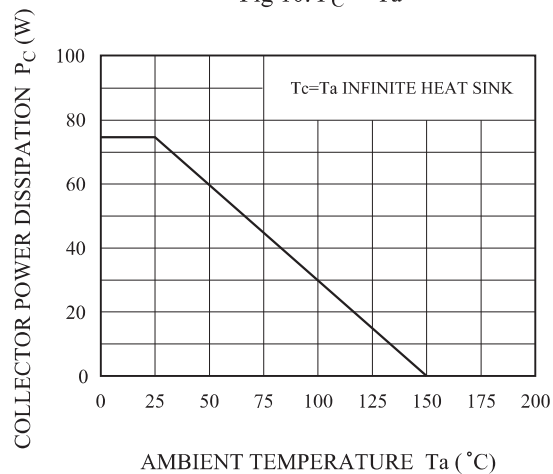
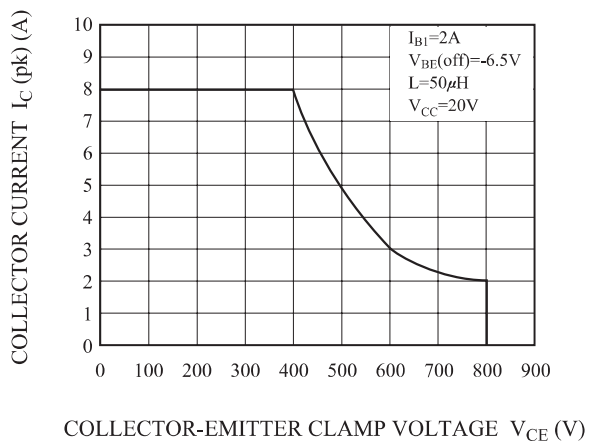
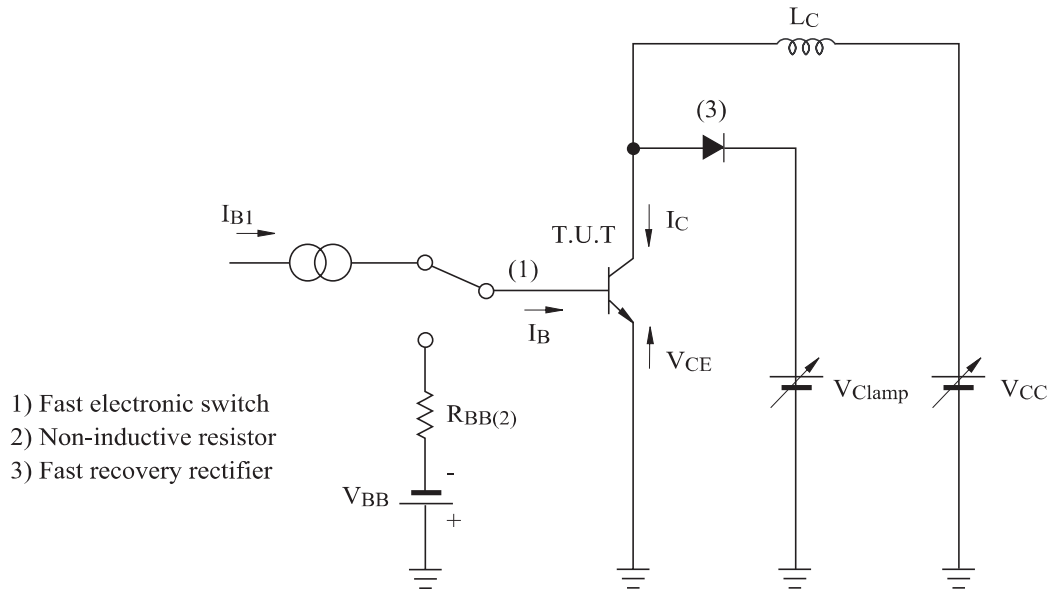

Fig 11. REVERSE BIASED SAFE OPERATING AREA



MJE13005D

REVERSE BIASED SAFE OPERATING AREA TEST CIRCUITS



For inductive loads, high voltage and high current must be sustained simultaneously during turn-off, in most cases, with the base to emitter junction reverse biased.

Under these conditions the collector voltage must be held to a safe level at or below a specific value of collector current.

This can be accomplished by several means such as active clamping, RC snubbing, load line shaping, etc.

The safe level for these devices is specified as Reverse Bias Safe Operating Area and represents the voltage-current conditions during reverse biased turn-off.

This rating is verified under clamped conditions so that the device is never subjected to an avalanche mode.

Figure 11 gives the complete RBSOA characteristics.