

N-CHANNEL SILICON POWER MOS-FET

■ **Features**

- High speed switching
- Low on-resistance
- No secondary breakdown
- Low driving power
- High voltage
- V_{GS}=±30V Guarantee
- Avalanche-proof

■ **Applications**

- Switching regulators
- UPS
- DC-DC converters
- General purpose power amplifier

■ **Maximum ratings and characteristic Absolute maximum ratings**

● (T_c=25°C unless otherwise specified)

Item	Symbol	Rating	Unit
Drain-source voltage	V _{DS}	800	V
Continuous drain current	I _D	±7	A
Pulsed drain current	I _{D(puls)}	±28	A
Gate-source voltage	V _{GS}	±35	V
Maximum Avalanche Energy	E _{AV*1}	378.3	mJ
Max. power dissipation	P _D	60	W
Operating and storage temperature range	T _{ch} T _{stg}	+150 -55 to +150	°C °C

*1 L=14.2mH, V_{CC}=80V

● **Electrical characteristics (T_c =25°C unless otherwise specified)**

Item	Symbol	Test Conditions	Min.	Typ.	Max.	Units
Drain-source breakdown voltage	V _{(BR)DSS}	I _D =1mA V _{GS} =0V	800			V
Gate threshold voltage	V _{GS(th)}	I _D =1mA V _{DS} =V _{GS}	3.5	4.0	4.5	V
Zero gate voltage drain current	I _{DSS}	V _{DS} =800V		10	500	μA
		V _{GS} =0V		0.2	1.0	mA
Gate-source leakage current	I _{GSS}	V _{GS} =±35V V _{DS} =0V		10	100	nA
Drain-source on-state resistance	R _{DS(on)}	I _D =3.5A V _{GS} =10V		1.62	2.0	Ω
Forward transconductance	g _{fs}	I _D =3.5A V _{DS} =25V	2.0	4.0		S
Input capacitance	C _{iss}	V _{DS} =25V		900	1350	pF
Output capacitance	C _{oss}	V _{GS} =0V		130	200	
Reverse transfer capacitance	C _{rss}	f=1MHz		70	110	
Turn-on time t _{on}	td(on)	V _{CC} =600V I _D =7A		25	40	ns
	t _r	V _{GS} =10V		90	140	
Turn-off time t _{off}	td(off)	R _{GS} =10 Ω		80	120	
	t _f			50	80	
Avalanche capability	I _{AV}	L=14.2mH T _{ch} =25°C	7			A
Diode forward on-voltage	V _{SD}	I _F =2I _D V _{GS} =0V T _{ch} =25°C		1.0	1.5	V
Reverse recovery time	t _{rr}	I _F =I _D V _{GS} =0V		900		ns
Reverse recovery charge	Q _{rr}	-di/dt=100A/μs T _{ch} =25°C		10		μC

● **Thermal characteristics**

Item	Symbol	Test Conditions	Min.	Typ.	Max.	Units
Thermal resistance	R _{th(ch-c)}	channel to case			2.083	°C/W
	R _{th(ch-a)}	channel to ambient			62.5	°C/W

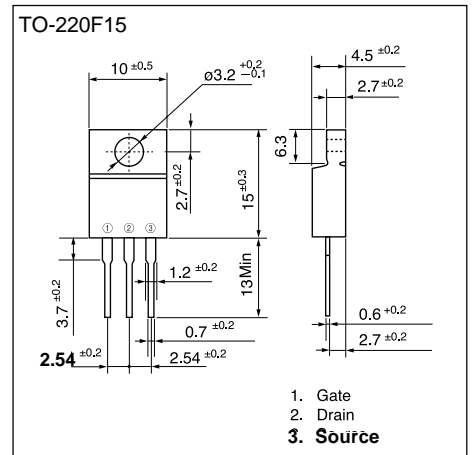

■ **Equivalent circuit schematic**

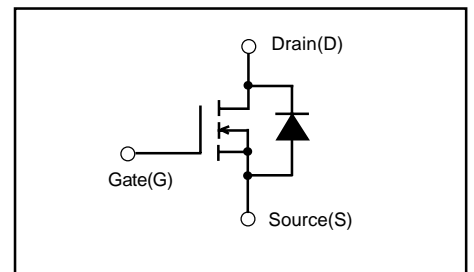

Characteristics

Typical output characteristics

$I_D=f(V_{DS})$:80μs pulse test, $T_c=25^{\circ}C$

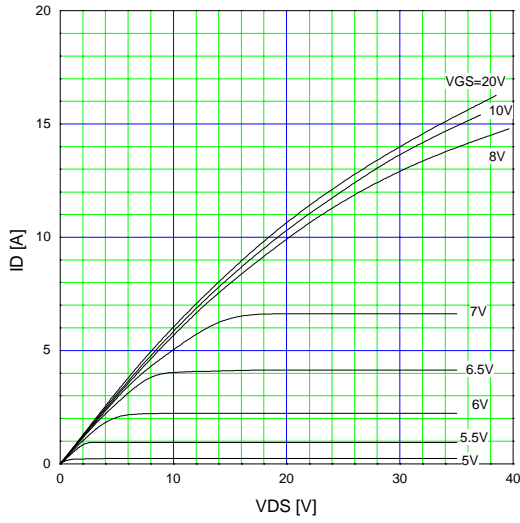

Drain-source on-state resistance

$R_{DS(on)}=f(T_{ch})$: $I_D=3.5A, V_{GS}=10V$

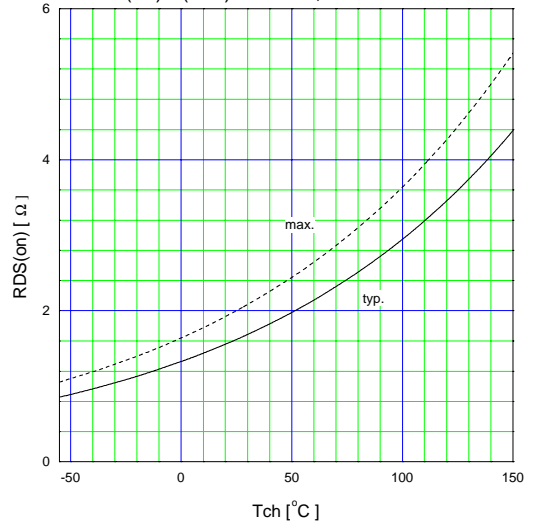

Typical transfer characteristic

$I_D=f(V_{GS})$:80μs pulse test, $V_{DS}=25V, T_{ch}=25^{\circ}C$

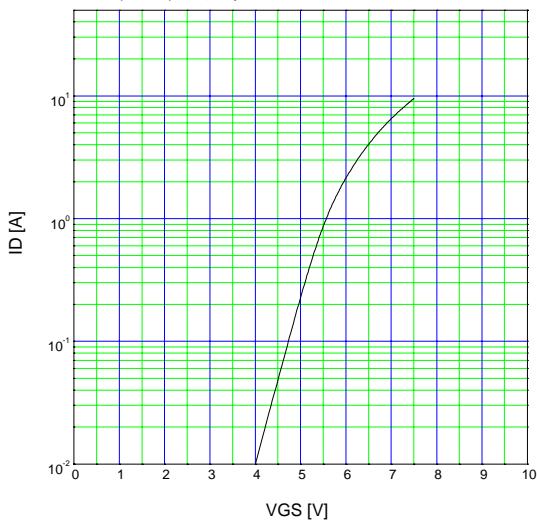

Typical Drain-Source on state resistance vs. Id

$R_{DS(on)}=f(I_D)$:80us pulse test, $T_{ch}=25^{\circ}C$

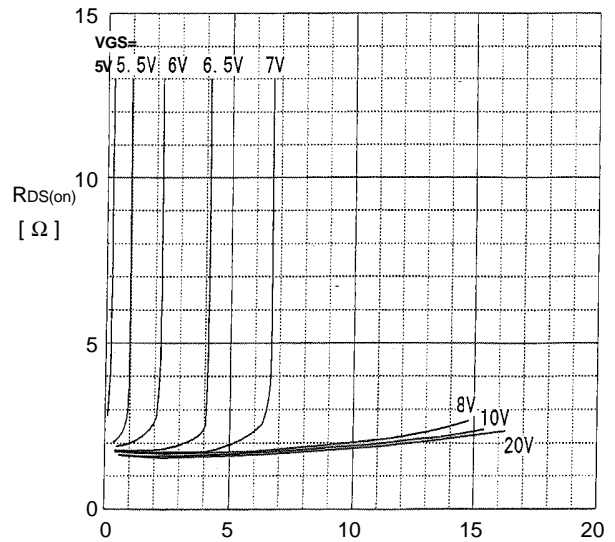

Typical forward transconductance

$g_{fs}=f(I_D)$:80μs pulse test, $V_{DS}=25V, T_{ch}=25^{\circ}C$

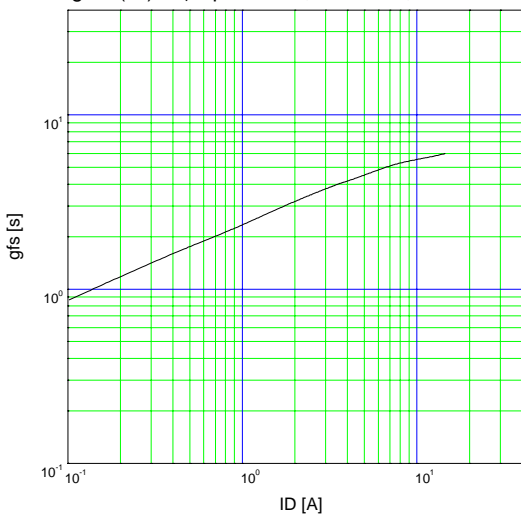

Gate threshold voltage

$V_{GS(th)}=f(T_{ch})$: $I_D=1mA, V_{DS}=V_{GS}$

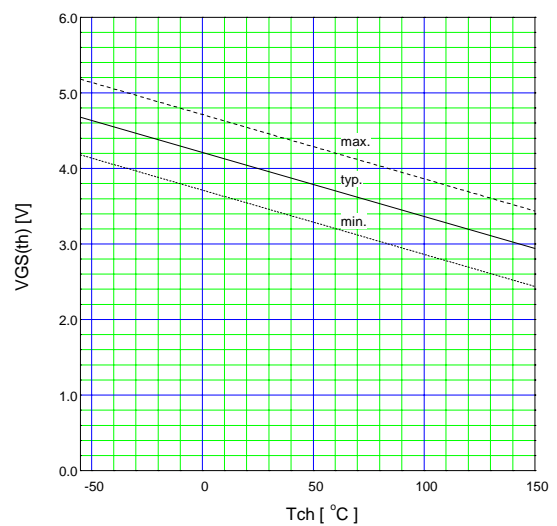

Typical capacitances
 $C=f(V_{DS}):V_{GS}=0V, f=1MHz$

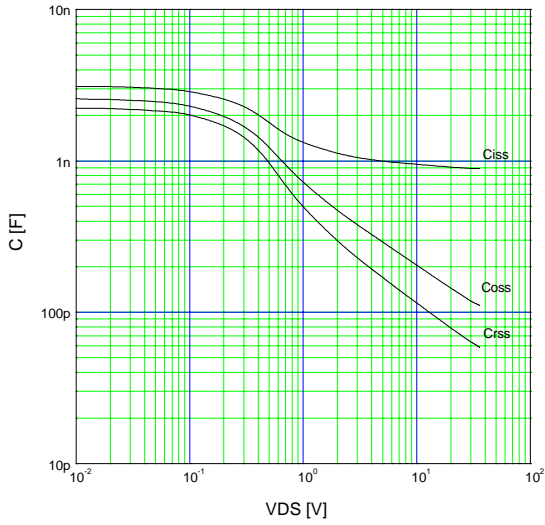

Typical gate charge characteristic
 $V_{GS}=f(Q_g):I_D=7A, T_c=25^\circ C$

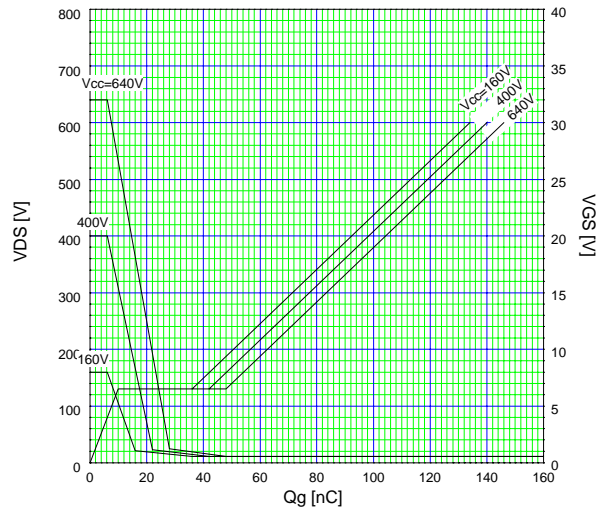

Forward characteristic of reverse of diode
 $I_F=f(V_{SD}):80\mu s \text{ pulses test}, V_{GS}=0V$

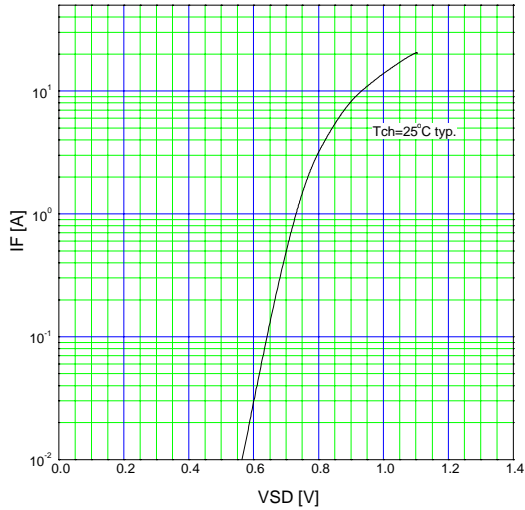

Power Dissipation
 $PD=f(T_c)$

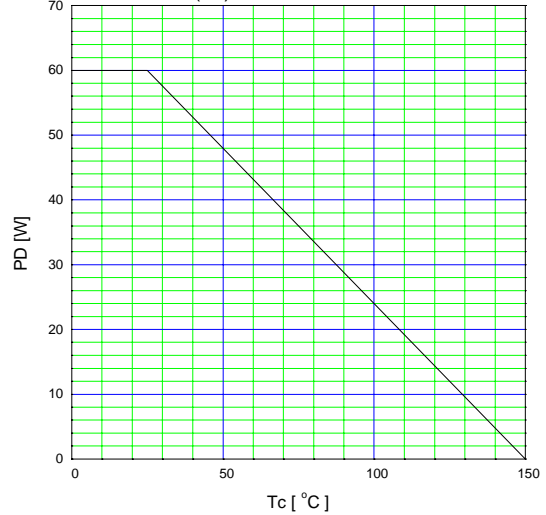

Transient Thermal Impedance
 $Z_{th}(ch-c)=f(t):D=t/T$

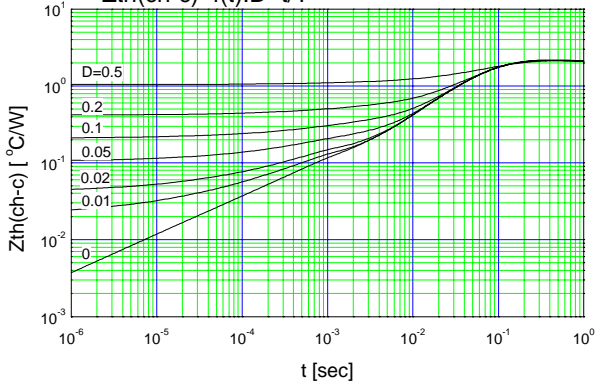

Safe operating area
 $I_D=f(V_{DS}):D=0.01, T_c=25^\circ C$

